

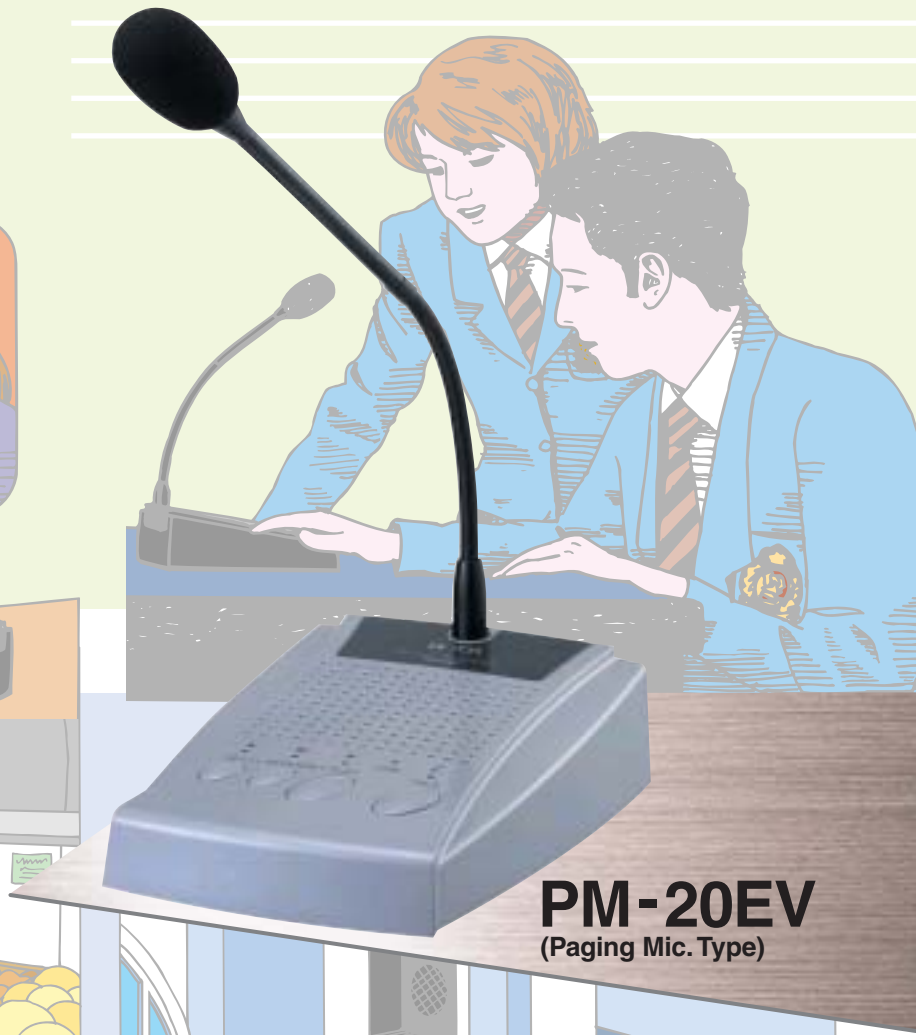

SOUND REPEATER

Digital announcements and simple recording makes high-quality broadcasts and announcements possible.



EV-20R
(Desktop Type)

safe&sound



Digital advantages contribute to enhanced ease of installation.

For department stores, offices, schools, stations and anywhere announcements are needed, the EV-20R and PM-20EV help assemble a system that makes good use of the advantages only digital technology can provide. Using flash memory for recording and storing messages allows unlimited announcement repeats without the sound deterioration associated with analog recording and repeated playback.



Main System Features

Digital advantages make all the difference.

Incorporating digital circuitry and technology do a lot to simplify operation and allow greater ease of use. The built-in flash memory provides enough storage capacity for up to three minutes of announcements. Recording perfect announcements becomes foolproof, allowing the user to overwrite mistakes until an announcement is perfect. Once announcements are ready, they can be programmed to repeat and sound quality is never compromised, even if a message is repeated over and over. The sound remains crisp and clear and easily intelligible thanks to digital recording/playback.

Recording quality is the same as CD-quality.

The reason for the extraordinary sound quality that the EV Series makes possible is that announcements are recorded in the same way as CDs at a 44.1kHz, 16 bit quantisation sampling rate. Recording is accomplished without using any compression for the best possible sound quality.

Digital also eliminates maintenance.

Since flash memory is used to store recorded announcements, there are no mechanical moving parts that could wear out with constant use, making the Sound Repeater maintenance-free. Even other digital systems that make use of CDs are subject to servicing at some time due to the CD mechanism that is incorporated.

Making sure recorded announcements are perfect.

To make recordings that are the best possible, an Automatic Gain Control (AGC) is built-in to eliminate differences in recording levels so that all announcements can be heard without annoying volume level variations.

Punctuating announcements with chimes.

Particularly useful in schools and stores, announcements can be prefixed and ended with a chime.

A CD-ROM containing a wide assortment of music selections and messages for specific situations as well as various chimes is included with the EV-20R and PM-20EV. It can be accessed on a PC connected to the EV-20R and PM-20EV via USB and the user can transfer whatever is desired.



anced performance, simpler recording

Unit Features



EV-20R

EV-20R Sound Repeater (Desktop Type)

- Up to 4 separate message selections or announcements to a total maximum of three minutes may be recorded for playback as desired. Front panel-mounted recording inputs (mic./line switchable) keep the process simple.
- A built-in interval timer allows messages to be repeated at various time intervals (0,5,10, and 30 seconds or 1,5,10, and 30 minutes or 1 hour or ∞).
- A 3W/8Ω amplifier section is built-in, allowing the EV-20R to be directly connected to speakers. A control for adjusting an external input source level is convenient when setting up programmed playback.
- A line input and output are included for connecting various other program sources including CD players or dedicated BGM units.

An EV-20R-based system has many applications in schools and educational facilities.

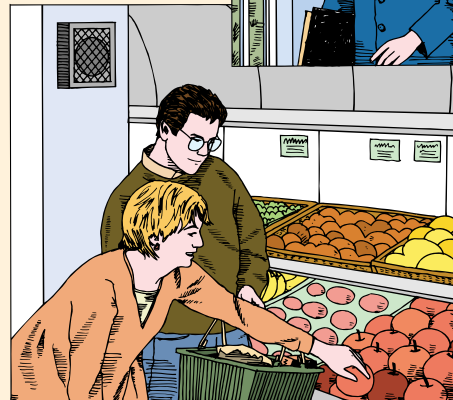
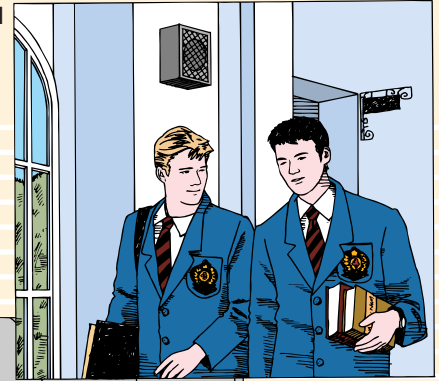

EV-20R used with a distributed speaker system proves ideal for use in supermarkets and department stores.

PM-20EV Sound Repeater (Paging Mic. Type)

- A microphone is included as standard equipment for recording and making announcements.
- Built-in monitor speaker allows checking announcements before broadcasting. (Rehearsal function)



- Automatic chime for marking the start and end of an announcement.

The PM-20EV helps familiarise people with broadcasting operations

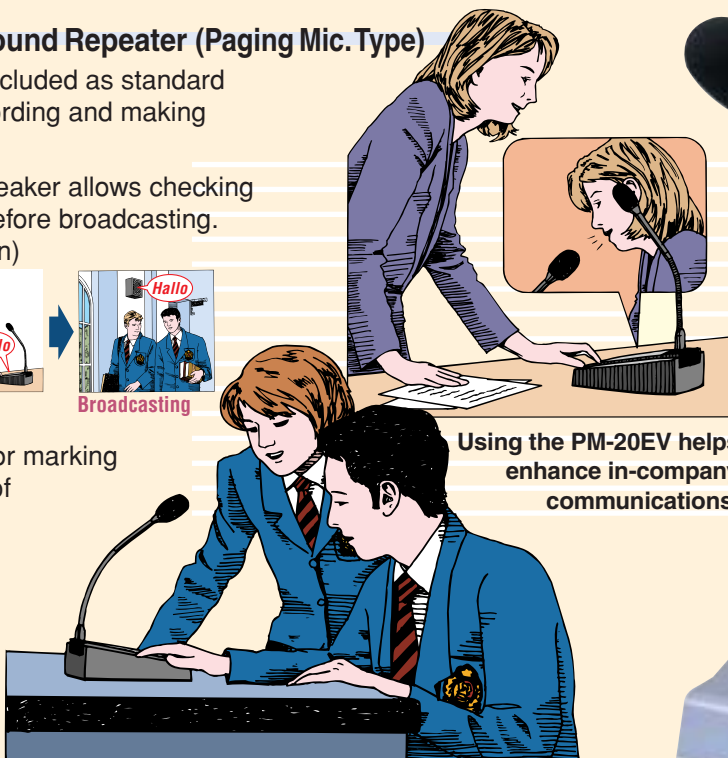

Using the PM-20EV helps enhance in-company communications.

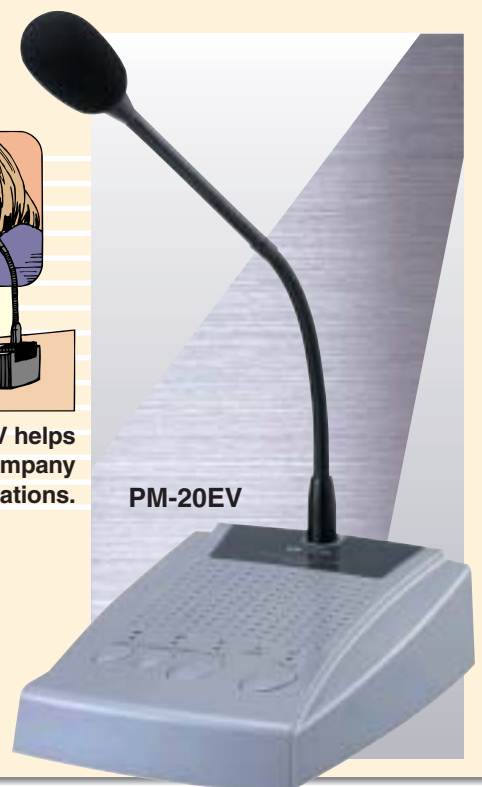

PM-20EV

SPECIFICATIONS

EV-20R		* 0dB = 1V
Power Source	Supplied from an external 24V DC/400mA power supply or from an optional AD-246 AC adapter	
Power Consumption	10W (rated output)	
Wave Format	44.1kHz sampling frequency, 16-bit PCM (monaural)	
Frequency Response	20 - 20,000Hz ±3dB (1kHz) 50 - 14,000Hz ±3dB (IT-450 mounted, 1kHz)	
Distortion	Under 1% (1kHz, rated output)	
Recording System	USB data transfer or analog recording	
Control Input	Play 1 - 4, stop: No-voltage make contact input, pulse make length : 200ms, open voltage: 30V DC, short-circuit current : 10mA terminal block type connector	
Control Output	Busy : Contact capacity: 30V DC/0.5A, terminal block type connector	
Input	Input / Recording input : Mic: -60dB*, 2.2kΩ/ Line: -20dB*, 10kΩ, (Mic/Line changeable), unbalanced, phone jack Line input : 0dB*, 10kΩ, unbalanced, terminal block type connector	
Output	Line output : 0dB*, 600Ω, unbalanced, terminal block type connector Headphone output : 0dB*, 100Ω, unbalanced, phone jack Speaker output : 3W, 8Ω, terminal block type connector	
LED Indicator	POWER, USB, START/STOP 1-4	
Maximum No. of Messages	4	
Maximum Recording Time	3 min	
Message Delay Time	0s, 2s or 4s (selectable)	
Playback Interval Time	∞, 0s, 5s, 10s, 30s, 1 min, 4 min, 10 min, 30 min or 1 h (selectable)	
Finish	Case : ABS resin, black	
Dimensions	210 (W) x 44.2 (H) x 181 (D) mm (excluding projection)	
Weight	730g	
Accessory	CD-ROM (USB data transfer software and sample chimes recorded) × 1, Unbalanced-phone plug × 1, USB cable (1m) × 1, Terminal block type connector (22 poles) × 1, Rubber feet × 4	

PM-20EV		* 0dB = 1V
Power Source	Supplied from an external 24V DC/200mA power supply or from an optional AD-246 AC adapter	
Power Consumption	5W	
Wave Format	44.1kHz sampling frequency, 16-bit PCM (monaural)	
Frequency Response	50 - 20,000Hz ±3dB (1kHz)	
Distortion	Under 1% (1kHz, rated output)	
Recording System	USB data transfer or analog recording	
Control Output	Busy: Contact capacity: 30V DC/0.5A, terminal block type connector	
Input	Unidirectional gooseneck microphone (preinstalled on the unit) External microphone: -37 dB*, 2.2kΩ, unbalanced, mini jack	
Output	Line output: 0dB*, 600Ω, balanced, phone jack, terminal block type connector Monitor speaker (built inside): 0.2W	
LED Indicator	USB, REC, MONITOR, PLAY, TALK	
Internal Chime Tone	2 tones (4-tone chime (Up) and 4-tone chime (Down)). ON/OFF operations	
Maximum No. of Messages	1	
Maximum Recording Time	3 min (including chime playback)	
Messages Delay Time	0s, 2s or 4s (selectable)	
Finish	Case: ABS resin, silver	
Dimensions	122(W) x 48.8(H) x 180(D)mm (microphone and projections not included)	
Weight	710g	
Accessory	CD-ROM (USB data transfer software and sample chimes recorded) × 1, USB cable (1m) × 1, Unbalanced-phone plug cord (2m) × 1, Terminal block type connector (7 poles) × 1	

USB Date Transfer Software Operation Environment

Personal Computer	IBM-AT compatible type (equipped with the USB terminal)
Main Specifications	CPU: Pentium compatible CPU of 133MHz or more Memory: Over 64MB (recommended: 128MB or more) Free disk space: Over 10MB (space for message storage excluded)
OS	Windows 2000/XP

Notes: Pentium is a trademark of Intel Corporation.
Windows is a trademark of Microsoft Corporation.
Other company names and products are also trademarks of individual companies.
Line input and line output can be converted to balanced type using an optional IT-450 transformer (EV-20R only).

Optional Accessories



Application Examples

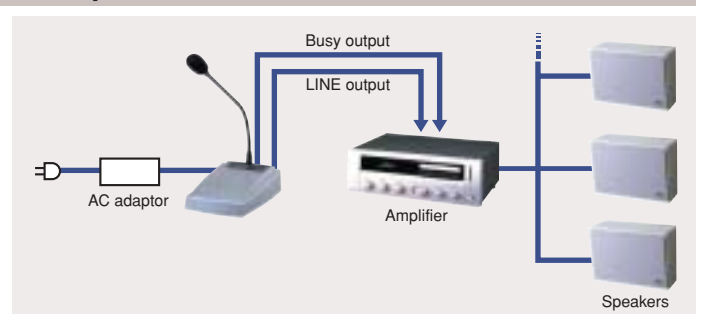
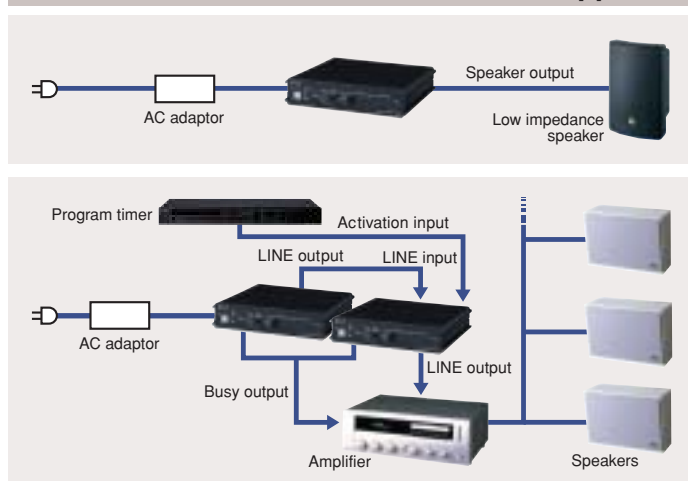

TOA Corporation

www.toa.jp

Specifications are subject to change without notice.
Printed in Japan (0303) 833-52-295-30 u